

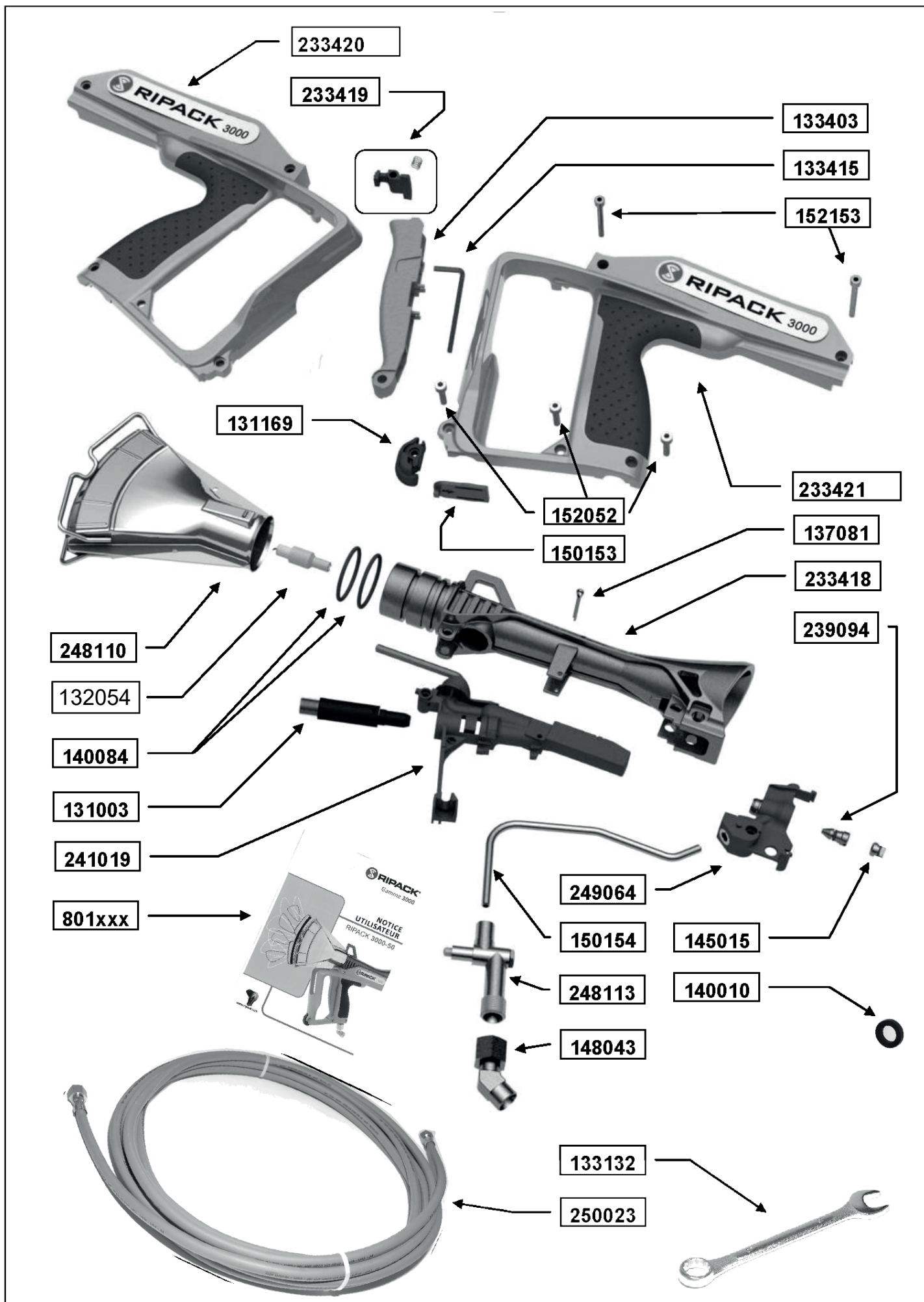

GRUPE SEFMAT

# RIPACK® 3000





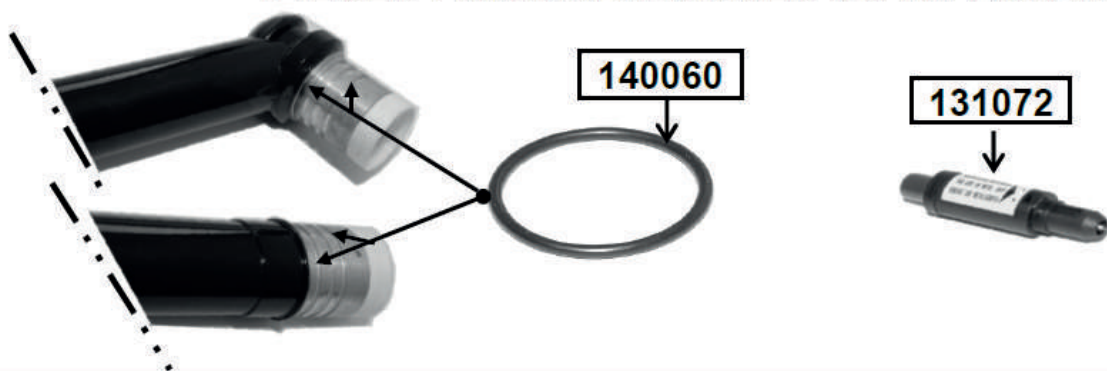

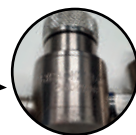

PIECES POUR RALLONGES DU RIPACK SERIES 3000

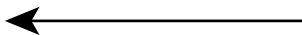

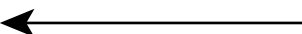
VÉRIFIEZ LA RÉFÉRENCE DE VOTRE DÉTENDEUR



<b>NF</b>		 <b>134022</b>
<b>UNI</b>		 <b>134023</b>
<b>DIN</b>		 <b>134024</b>
<b>USBS</b>		 <b>134025</b>

<b>Code art.</b>	<b>Désignation</b>
131003	Allumeur piezo pour Ripack Series 3000 <b>sans</b> rallonge
131072	Allumeur piezo pour Ripack Series 3000 <b>avec</b> rallonge
131169	Amortisseur
133132	Clé plate de 19
133403	Gâchette
133415	Clé Allen 3
137039	Graisse MOLYKOTE
137081	Goupille masse
140010	Joint plat Securipack NF - UNI
140061	Joint torique Ø intérieur 28,24 x 2,62 DIN pour rallonge
140084	Joint torique Ø intérieur 34,82 x 3,53 DIN
145015	Obturateur injecteur Ripack Series 3000
148043	Raccord tournant
150153	Trappe piezo
150154	Tube aluminium alimentation gaz
152052	Vis CHc M4x16
152153	Vis CHc M4x35
132054	Bougie d'allumage
233418	Corps de pistolet avec joints toriques DIN
233419	Clique + ressort
233420	Demi-poignée droite + étiquette Ripack 3000
233421	Demi-poignée gauche + étiquette Ripack 3000
239094	Injecteur propane standard DIN
241019	Kit connexion électrique Ripack <b>sans</b> rallonge
241020	Kit connexion électrique Ripack <b>avec</b> rallonge
248110	Buse de combustion
248113	Robinet gaz DIN
249064	Support d'injecteur complet DIN (inclus : support, injecteur, obturateur)
250023	Tuyau haute pression DIN long. 8 mètres, Ø int. 4, avec colliers & raccords
801xxx	Notice d'utilisation Ripack 3000-50